

Science of Cellular Communication

Kaznacheyev also found the converse, that healthy cultures could “walk back” a diseased one into a state of health.

These experiments were widely replicated in the USSR and also in Europe and published in peer reviewed journals.

The take away message is that disease can be initiated simply by the transfer of frequencies from one source to another: one cell culture to another or one person to another.

Your Key Fob Works Like a Cell

The key fob is the transmitter which sends a signal to a receiver in the door.

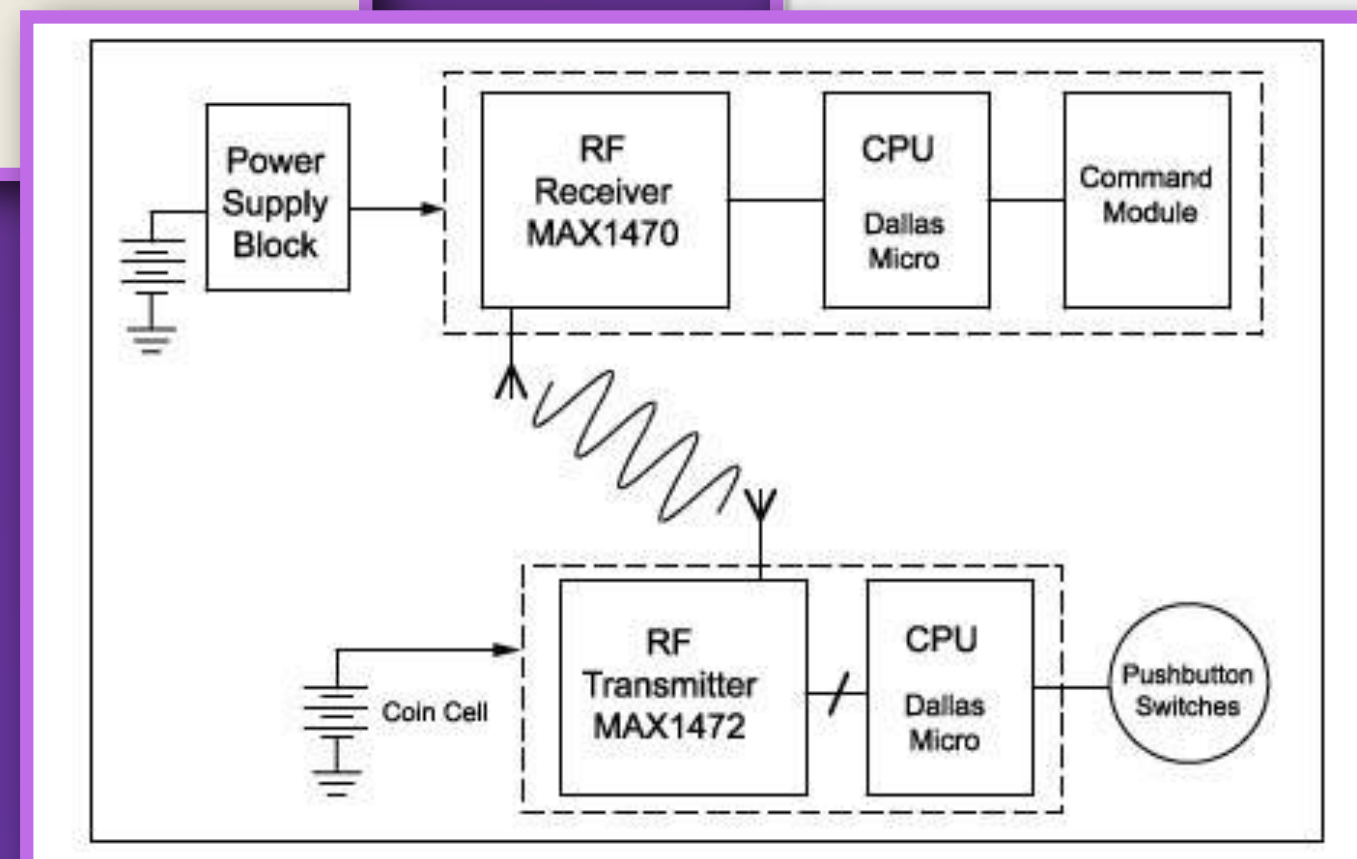

How Does Energy Medicine Work?

Dr. Bruce Lipton's research in the 1960s documented that the genes **DO NOT** control cell function. Environmental factors (EMFs) affect the receptors on the cell membrane which stimulate physiological functions within cells.

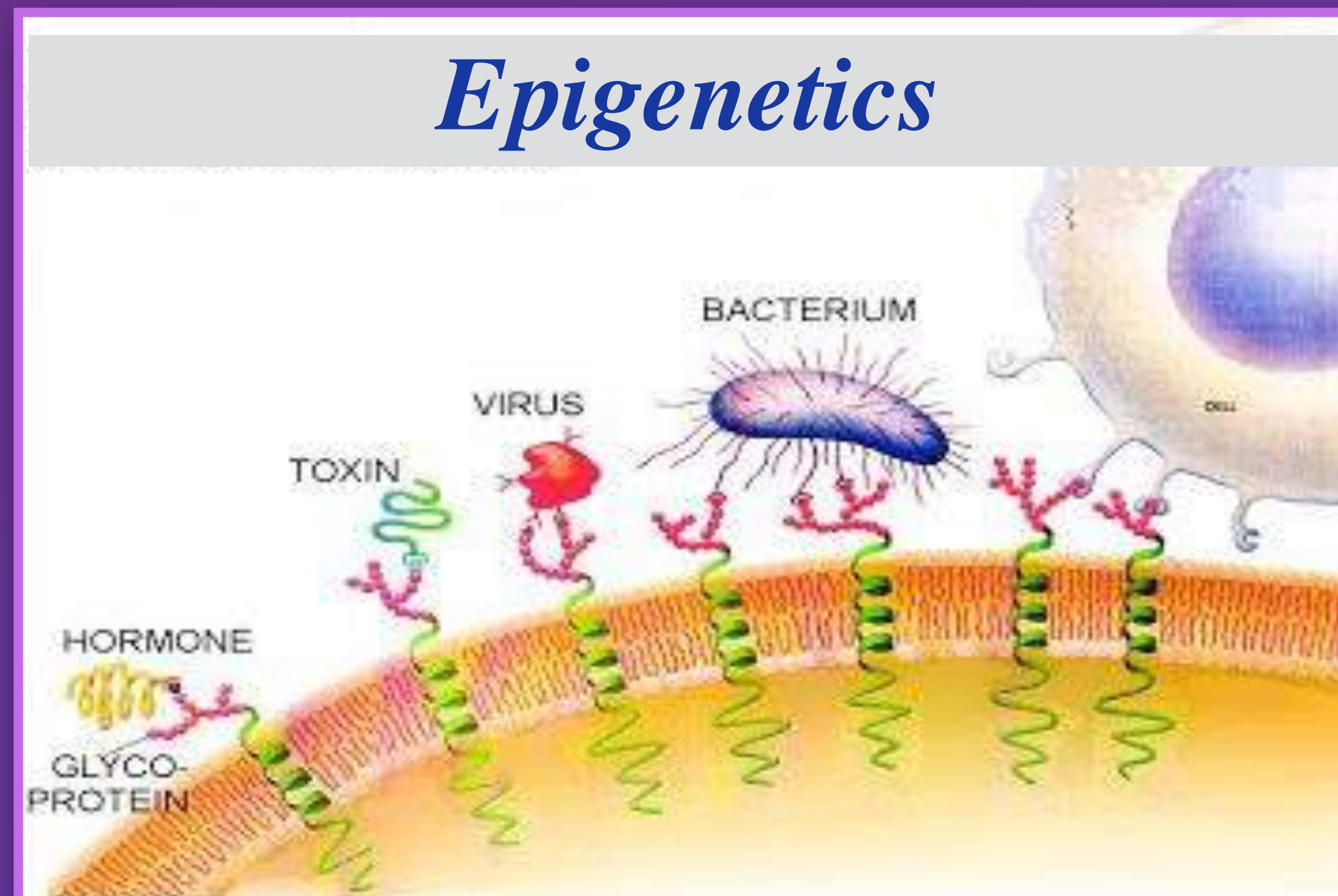

Internal Cell Organelles

When stimulated, the internal organelles react. Mitochondria produce energy; they also signal and coordinate the function of all the other components.

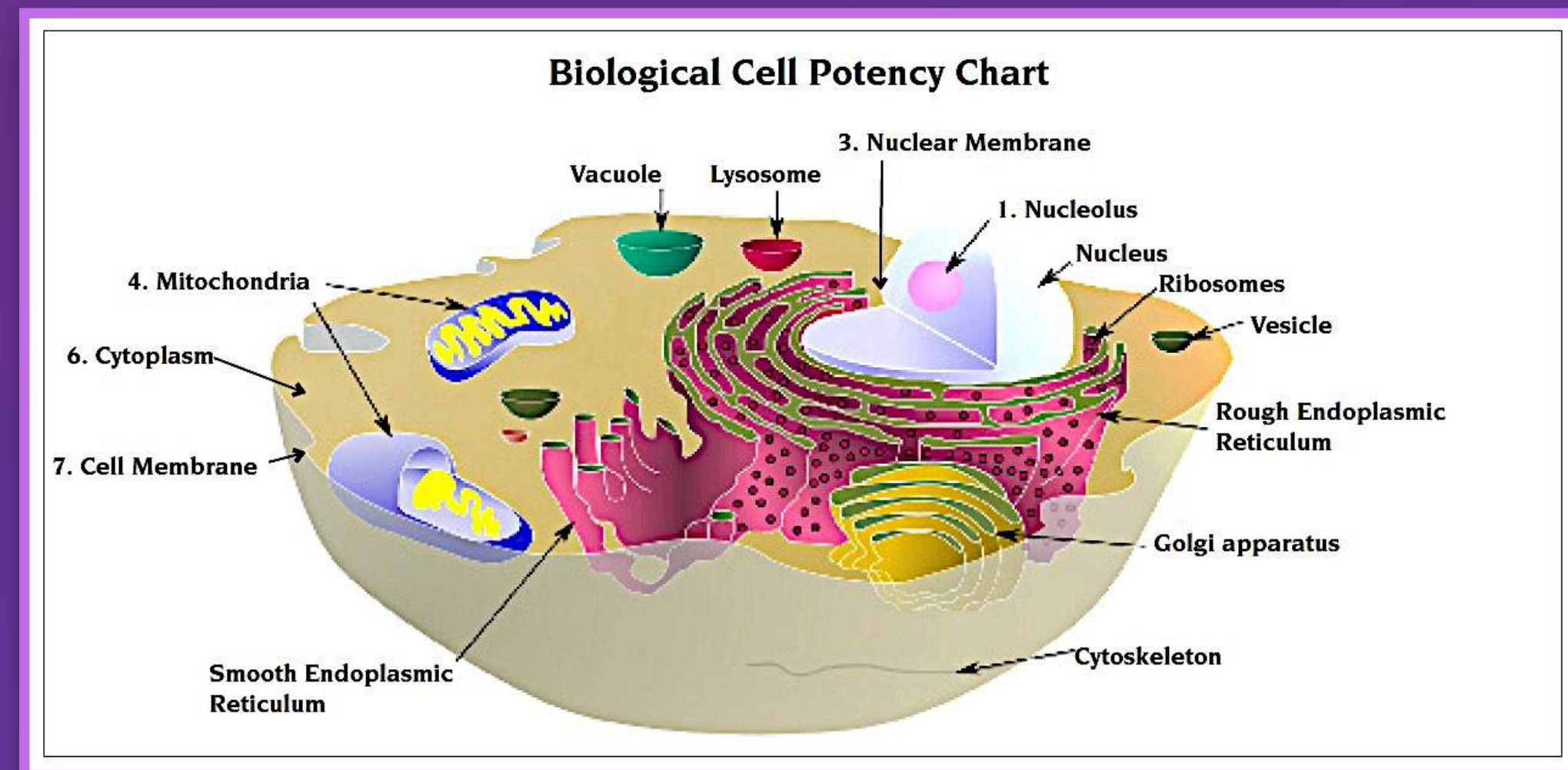
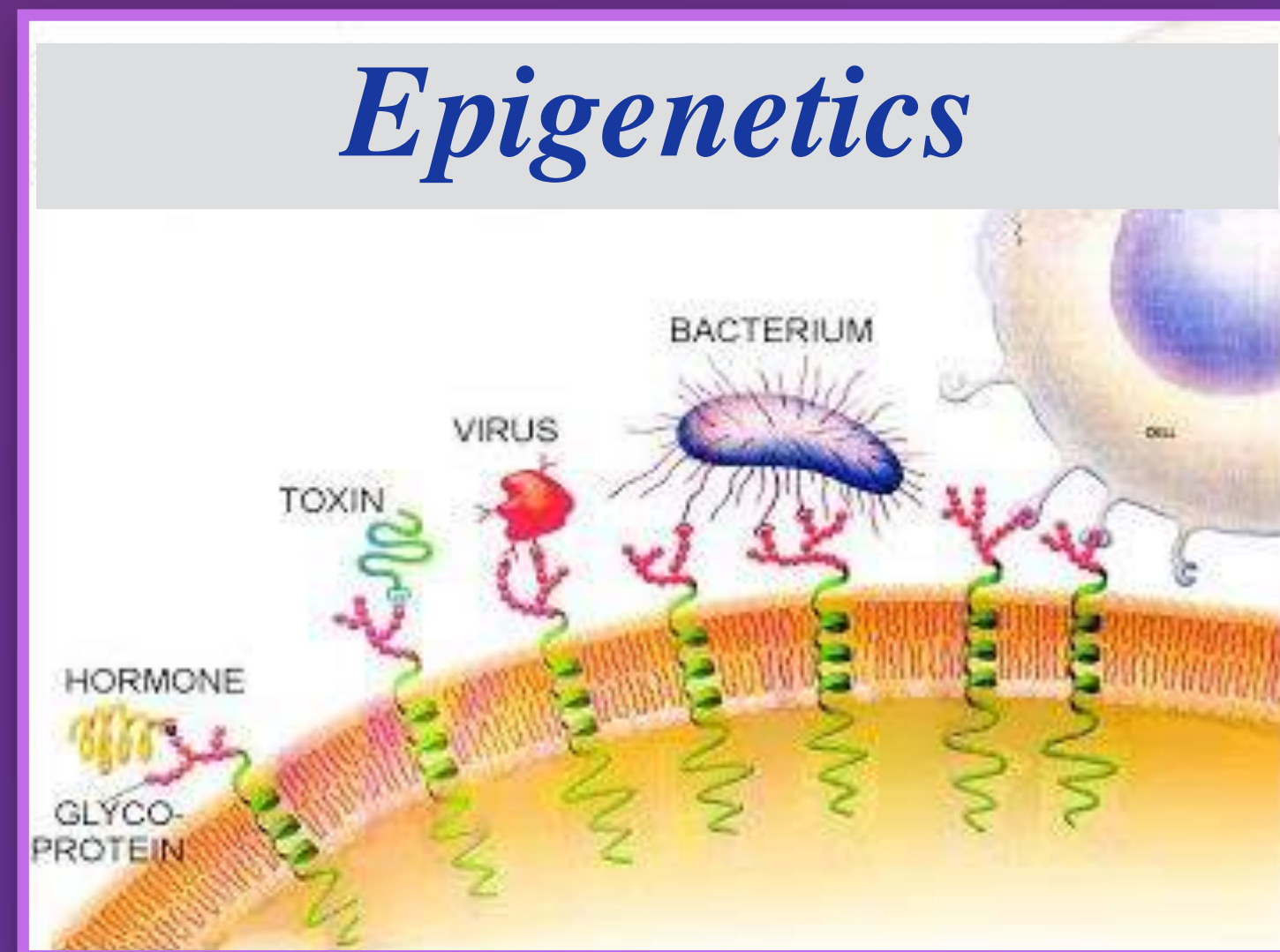

Endoplasmic reticulum processes proteins. Ribosomes synthesize the proteins. Golgi apparatus packages the protein for export.

Frequencies Used in Healing

Science of Frequencies in Healing

Rife built his research off of studies conducted by a 20th-century scientist, Dr. Albert Abrams, who believed:

All matter vibrates (that vibration is what we call frequency), and vibrations were specific to the type of matter and what it's made of.

Building on Dr. Abrams' research, Dr. Rife theorized that cancer cells and pathogens could be targeted by outside electromagnetic frequencies (EMFs). Then, the cells would undergo apoptosis (cell death, where it will either implode or explode). This was the genesis of the rife machine, a tool that matches the specific frequency of different cancer cells and pathogens delivering low-energy electromagnetic waves to the body.

Science of Frequencies in Healing

In the 1920s and '30s, Dr. Royal Raymond Rife—a bacteriologist studying at John Hopkins University—observed that viruses, bacteria, and cancer cells had their own resonance frequencies.

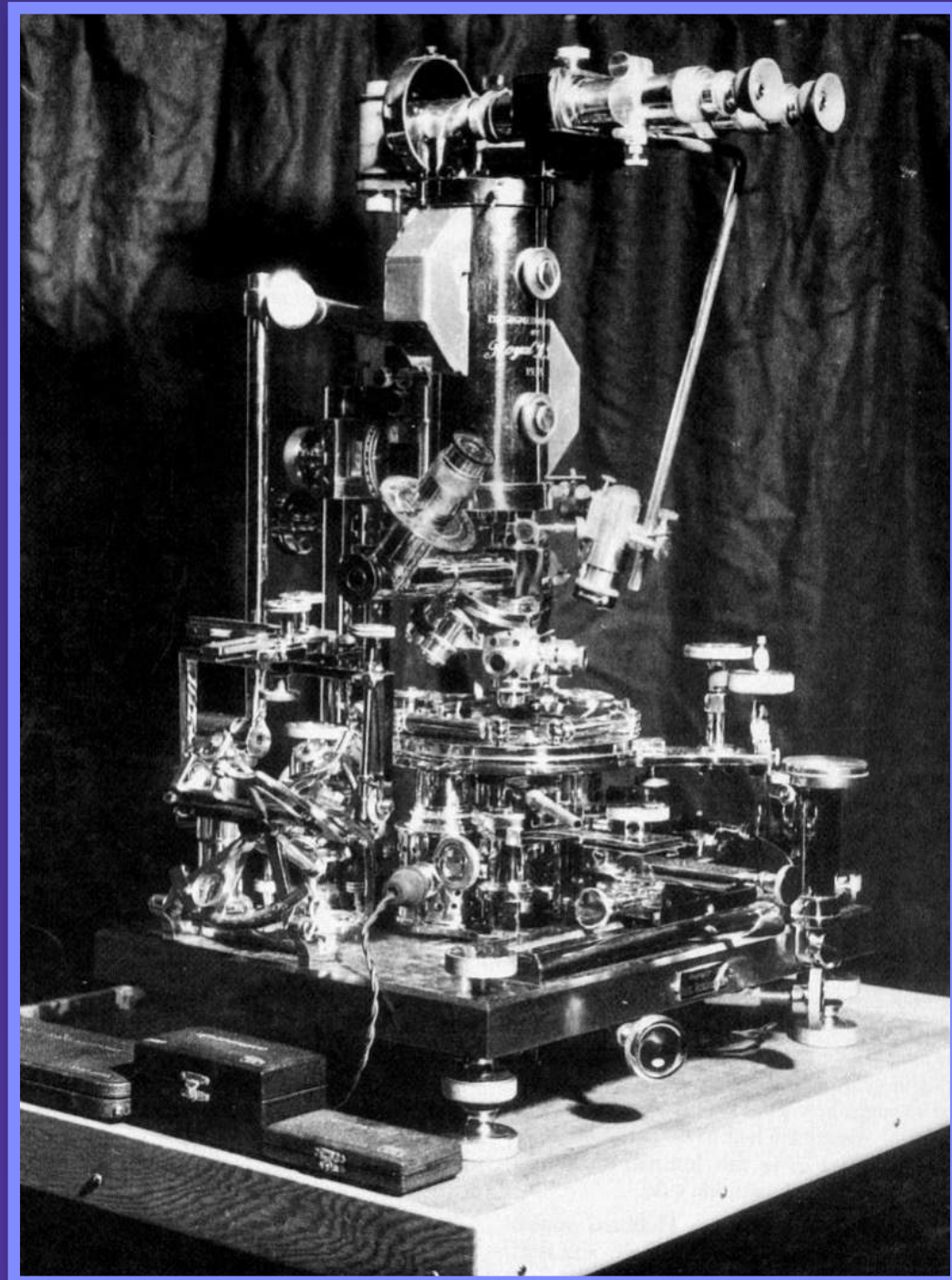

Rife Universal Light microscope was used to determine the mortal oscillatory frequency that destroyed pathogens. By subjecting the pathogen with the same frequency that it vibrated, Rife was able to explode it without harming any surrounding cells.

Rife Technology

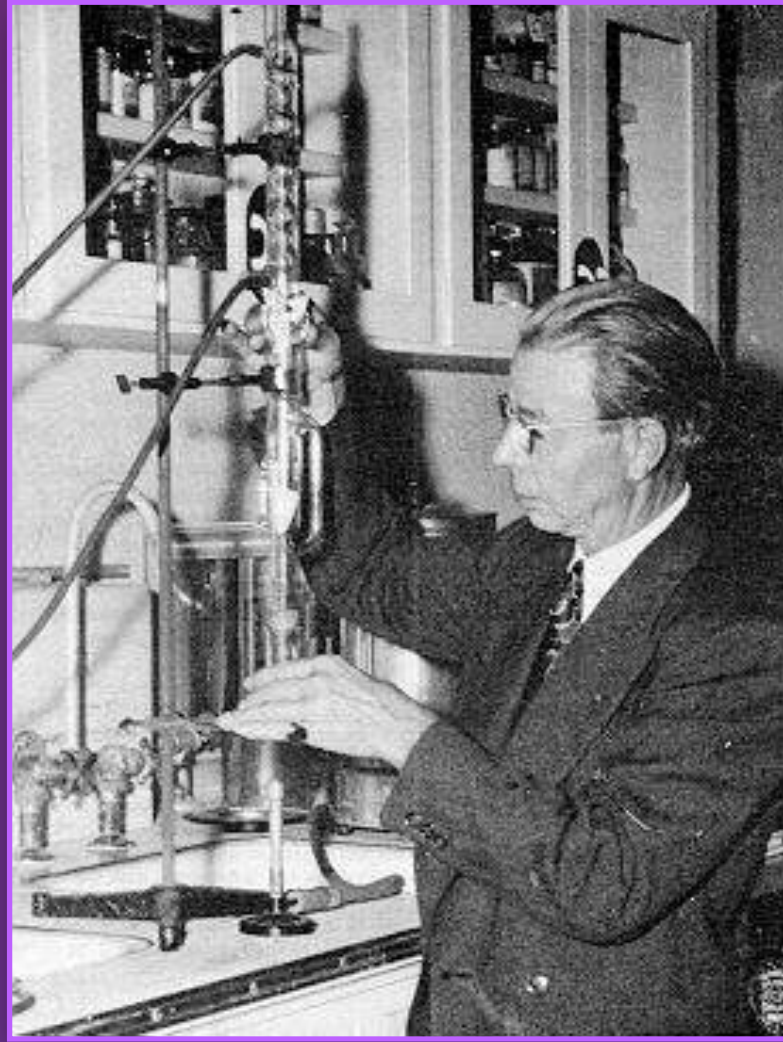

Royal
Raymond Rife
1888-1972



Treatment with the frequency instrument causes no tissue to be destroyed and no pain is felt. The virus or bacteria is destroyed and the body then recovers itself naturally from the toxic effect of the virus or bacteria.

Science of Frequencies in Healing

In 1934, Dr. Rife conducted experiments on 16 terminal cancer patients. His rife machine cured 14 of the 16 patients in 130 days, and the other two patients were reported to be cured in six weeks.



The Cancer Cure that Worked: Fifty Years of Suppression

Barry Lynes

Earlier version of a
Rife Generator

Chronic Post-Extraction Pain



Melissa P. suffered searing pain in the maxillary left third molar extraction site for one year following removal of her third molar. No one made the diagnosis of shingles! Two months prior to the extraction Melissa had an out break of shingles on her back. Non one connected the dots.

Virtual Injection

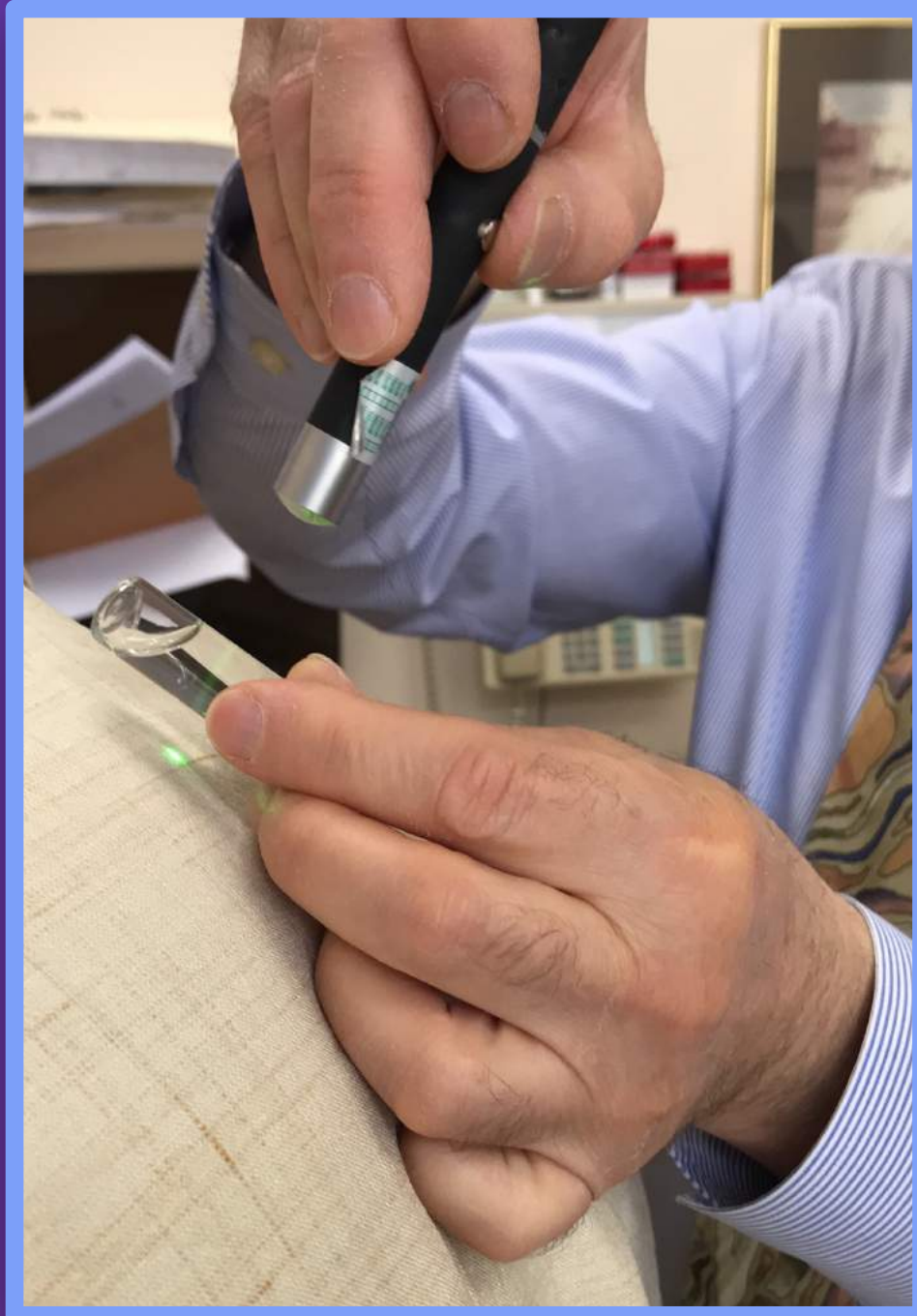

Test patient for
best frequency:
green (532 nm) or
infrared (650 - 880 nm)



Pain caused by
Glyphosate in liver



Test remedy then pulse
into the area where the
toxin or pathogen exists

Virtual Injection

Dale B. presented with the chief complaint of pain in a post-root canal extraction site and swollen lymph nodes under her mandible on the left side. Dx revealed CMV in the alveolar bone and submandibular lymph nodes. One minute following the infrared laser pulsing through Cat's Claw homeopathic (Energtix) remedy the patient reported that her pain totally resolved and she felt more clear headed.



Virtual Injection



Within one minute following the virtual injections, Dale stated that her jawbone pain disappeared and that she felt more clear headed and could see more clearly.

Virtual Injection



With the increase of dementia and other neurological maladies, new technology is required to address these issues. Defining the “splinters” in the brain and erasing the toxic frequencies by means of pulsed infrared laser, is one noninvasive way of treating these abnormalities.

Virtual Injections for Parkinson's



Initially the patient walked in at a snails pace. Following virtual injections and Theraphi, patient's pace quickened markedly.

Energy Medicine Technology

Energetic Healing

Cutting edge infrared technology coupled with vibratory sound frequencies to heal the brain and rest of the body.

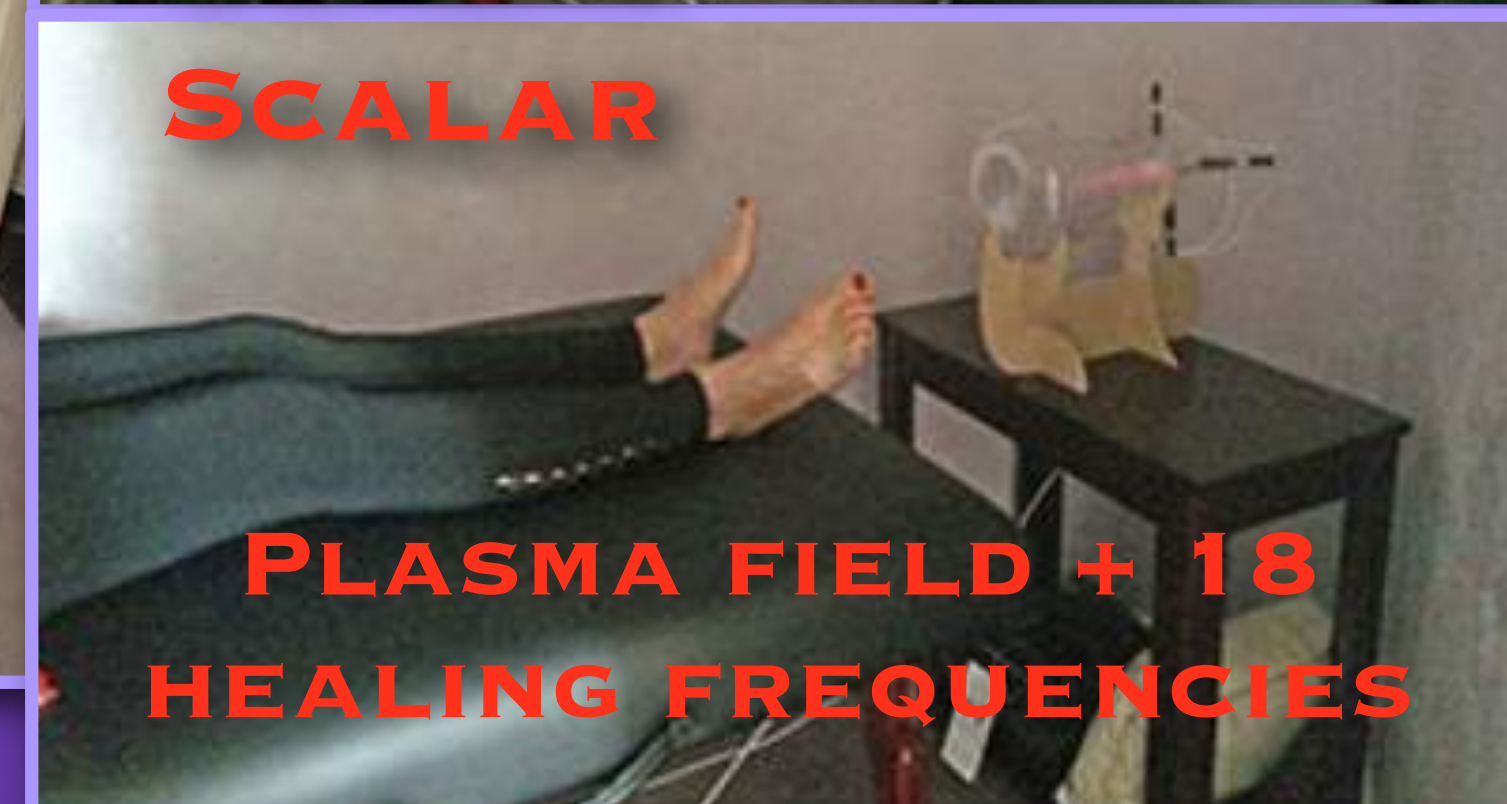

Theraphi Plasma System



Five months of left knee pain resolved in two 5 minute sessions - a day a part.

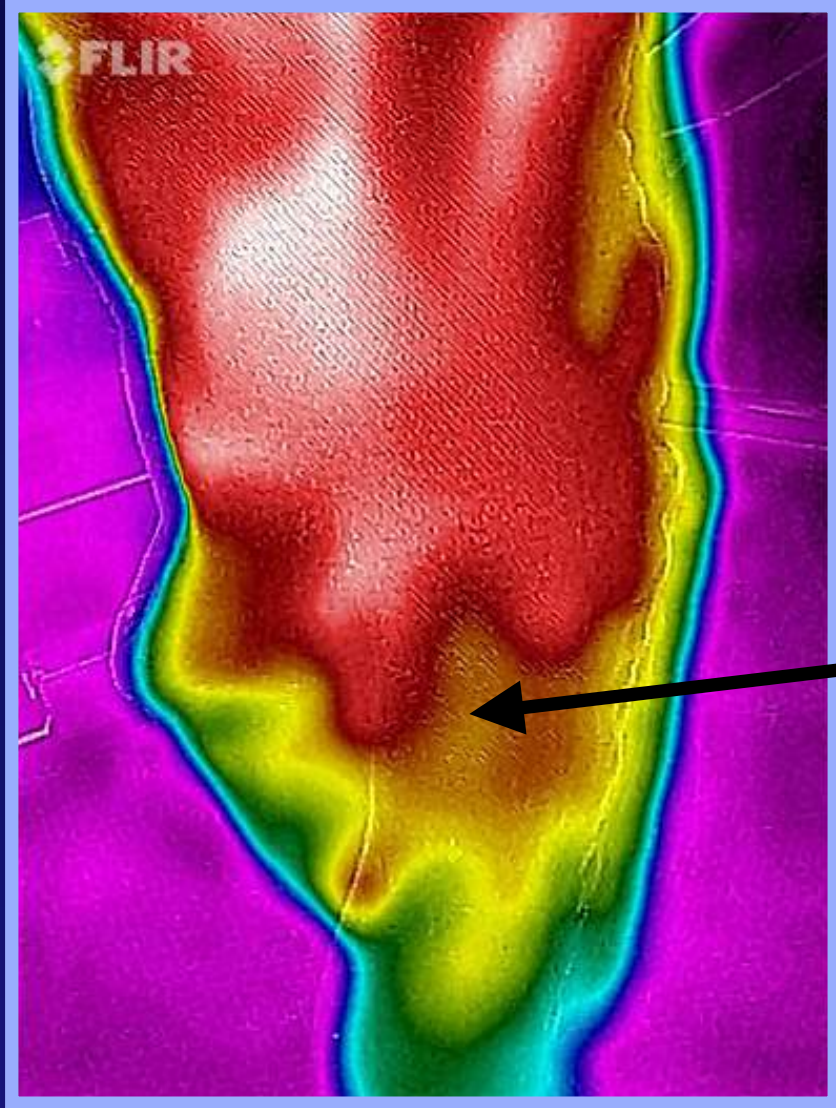

Pre-Tx
81.87°F

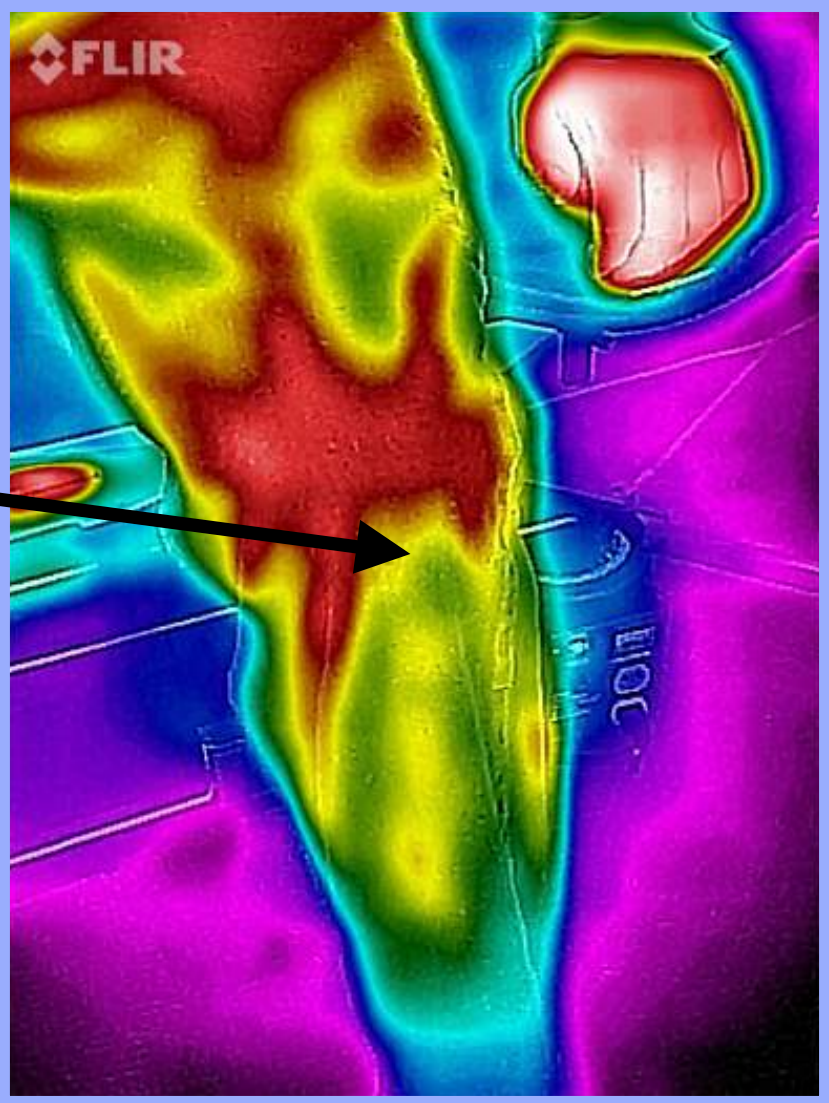

Post-Tx
70.33°F

11.54°F drop

BIOPHOTON PEN SYSTEM



The Biophoton Pen System has four frequencies. Two are designed to heal the DNA; one is a general detox frequency, and the fourth is a general healing frequency.

BIOPHOTON PEN SYSTEM

Initial clinical research by Dr. Ngui has shown that 10 Hz allows the light to be absorbed more easily.

Dr. Ngui also discovered that a duty cycle of 60% was more physiologic and absorbed more easily.



The Biophoton Pen System has a computer enabling the practitioner to change the frequency of the pulsations and also the duty cycle.

INFRARED DOCUMENTATION

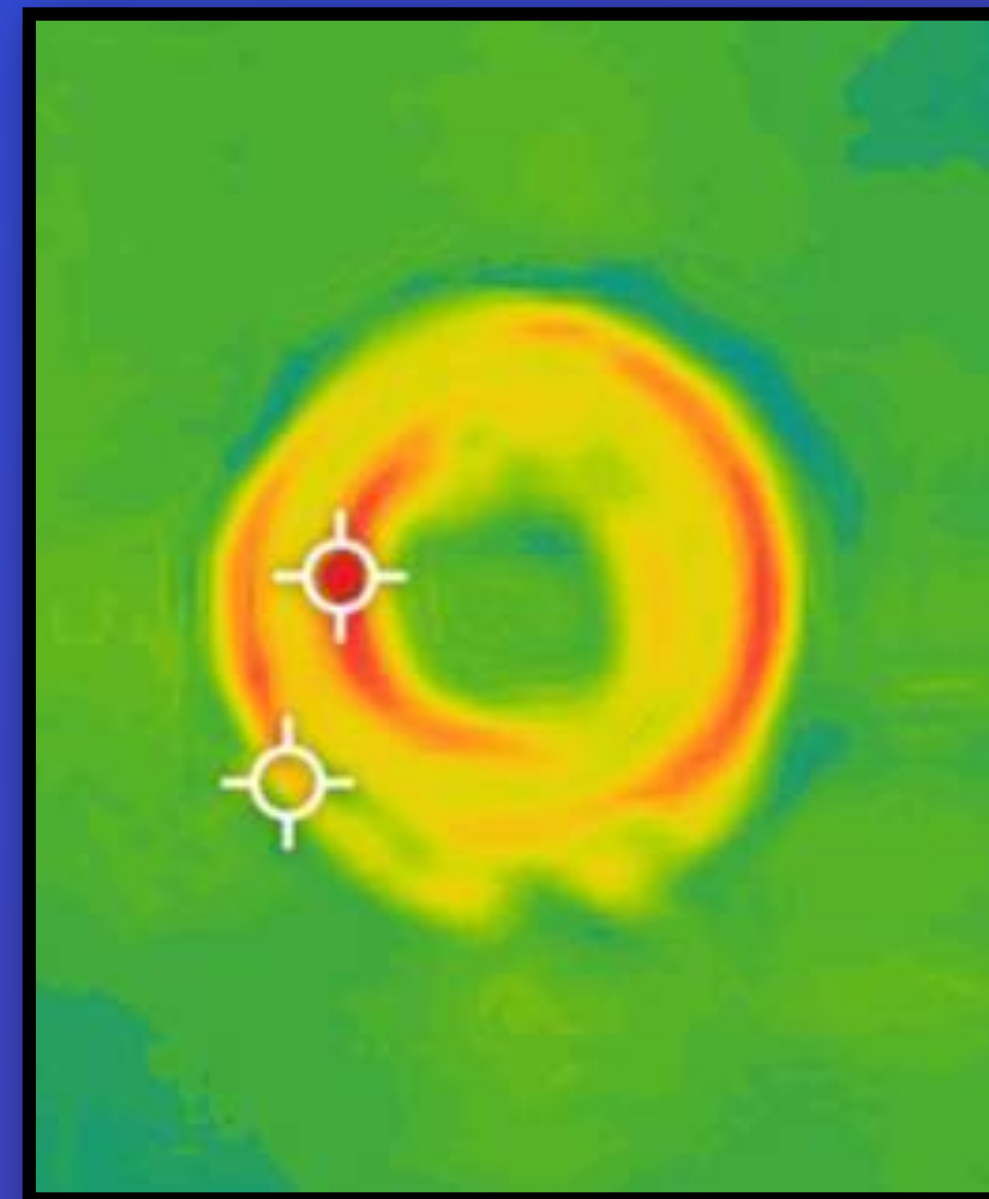

Pre-Imprinting

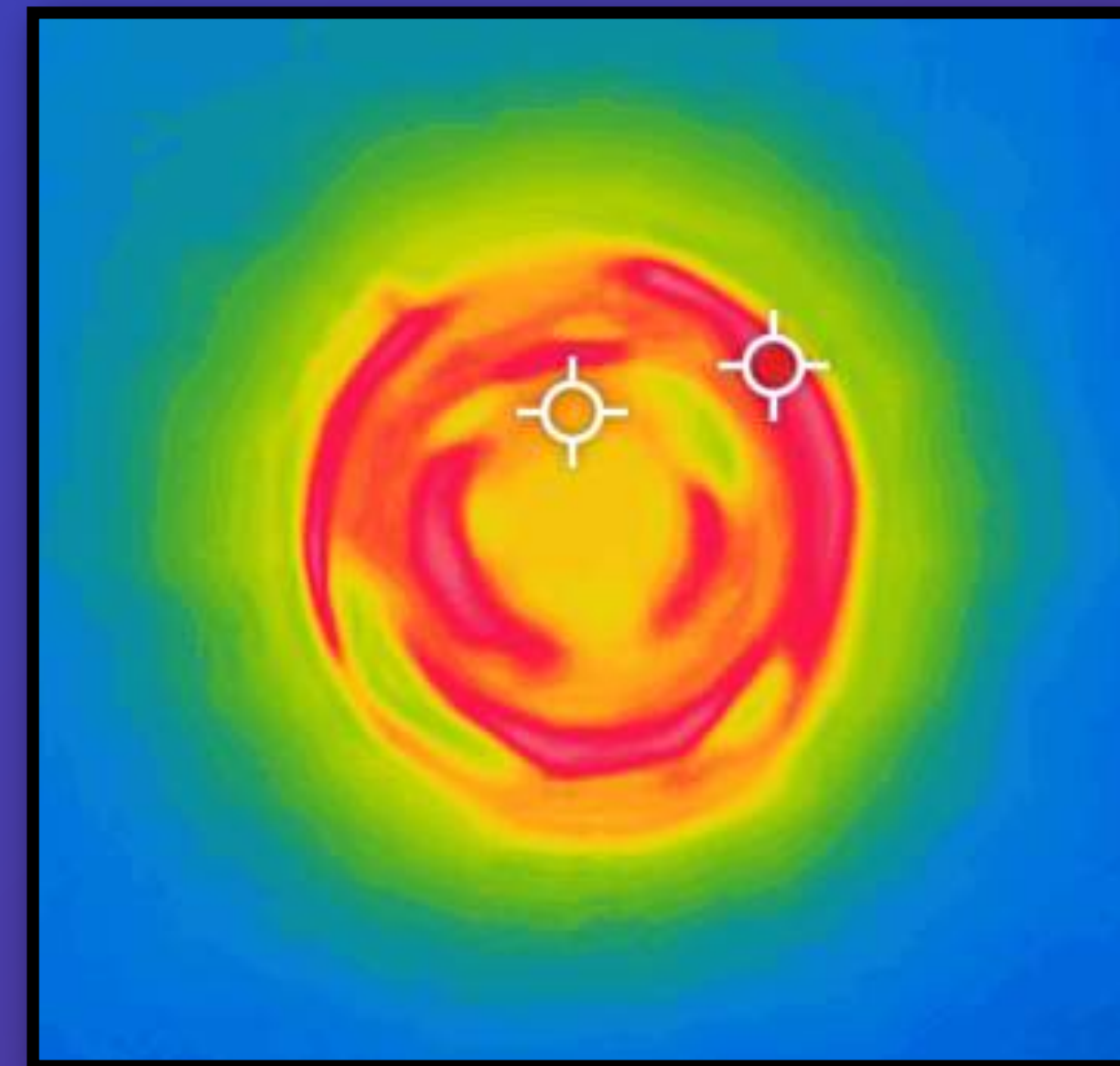

Post-Imprinting

This infrared photo was taken of a jade donut before imprinting with the Biophoton frequencies. The second photo exhibits the increased heat or energy pattern following imprinting with the four frequencies.

Science of Frequencies in Healing

Based on the research of Vlail Kaznachev, Dr. Royal Ramond Rife, Fritz Albert Popp, Dr. Bruce Lipton's Biology of belief and others, the Tesla Energy Card[®] was born.

The advantage of the Tesla Energy Card[®] is that it provides an affordable way to program specific frequencies to retune any dysfunctional cell, tissues or organs.

What is the Tesla Energy Card®?

The Tesla Energy Card® is a credit card sized device that has a magnetic strip on the backside. Through a sophisticated electronic process, specific healing frequencies can be programmed into the strip. The imprinted frequencies will last for one to two years provided the card is not directly exposed to a cell phone for 5 to 10 minutes or exposed to a strong magnet. In reality the Tesla Energy Card® is a unique delivery system for healing the body.



How Does it Work?

There are two primary ways to transmit the frequencies into the body:

1. Wear the Tesla Energy Card® with the magnetic strip facing your body. The body's aura, which is an extension of the autonomic nervous system, picks up the frequencies and transfers them into your body.
2. Imprint a glass or bottle of water by placing the glass or bottle directly on the magnetic strip of the Tesla Energy Card®. Imprinting takes fifteen seconds to three minutes.

Tesla Energy Card® On Body

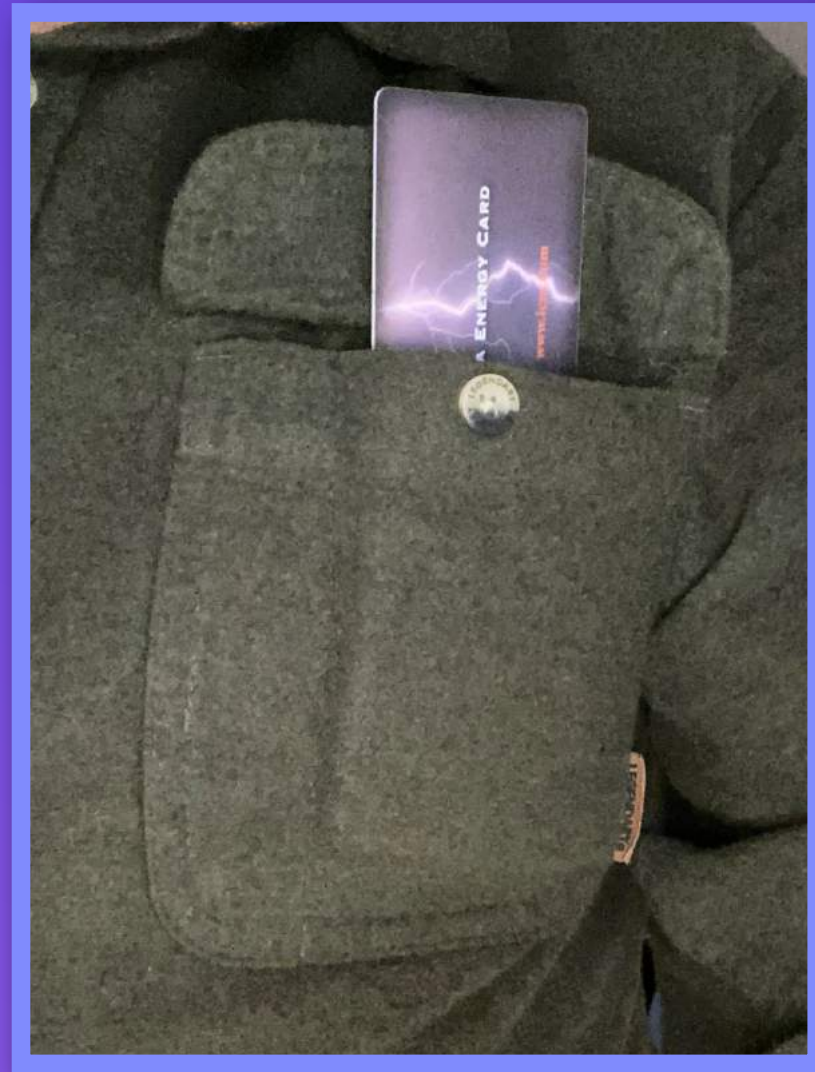

Correct Position



Incorrect Position

The magnetic strip on the Tesla Energy Card® must face toward the body.

Imprinting Water with the Tesla Energy Card®



Correct Position



Correct Position

The magnetic strip on the Tesla Energy Card® must face upward into the water. Imprinting takes 15 sec. to 3 minutes to complete.

Testimonials

Post Shingles Nerve Damage Resolved



Kristine Rizzo had to wear a lidocaine patch for the past two to three years because of nerve damage that resulted from shingles in her right leg. After one month of wearing her imprinted crucifix, her nerve pain totally resolved.

Tendonitis Averted with Frequencies



Ed Young felt his tendonitis coming on, which was quickly averted by treating his right arm with a frequency program delivered from an iPhone.

The FrequencyShop.co is a subscription website that offers frequency programs that can be delivered from one's iPhone, iPad, tablet, laptop, or desktop computer anywhere, anytime, and to anyone.

Flu/COVID Averted with Frequencies

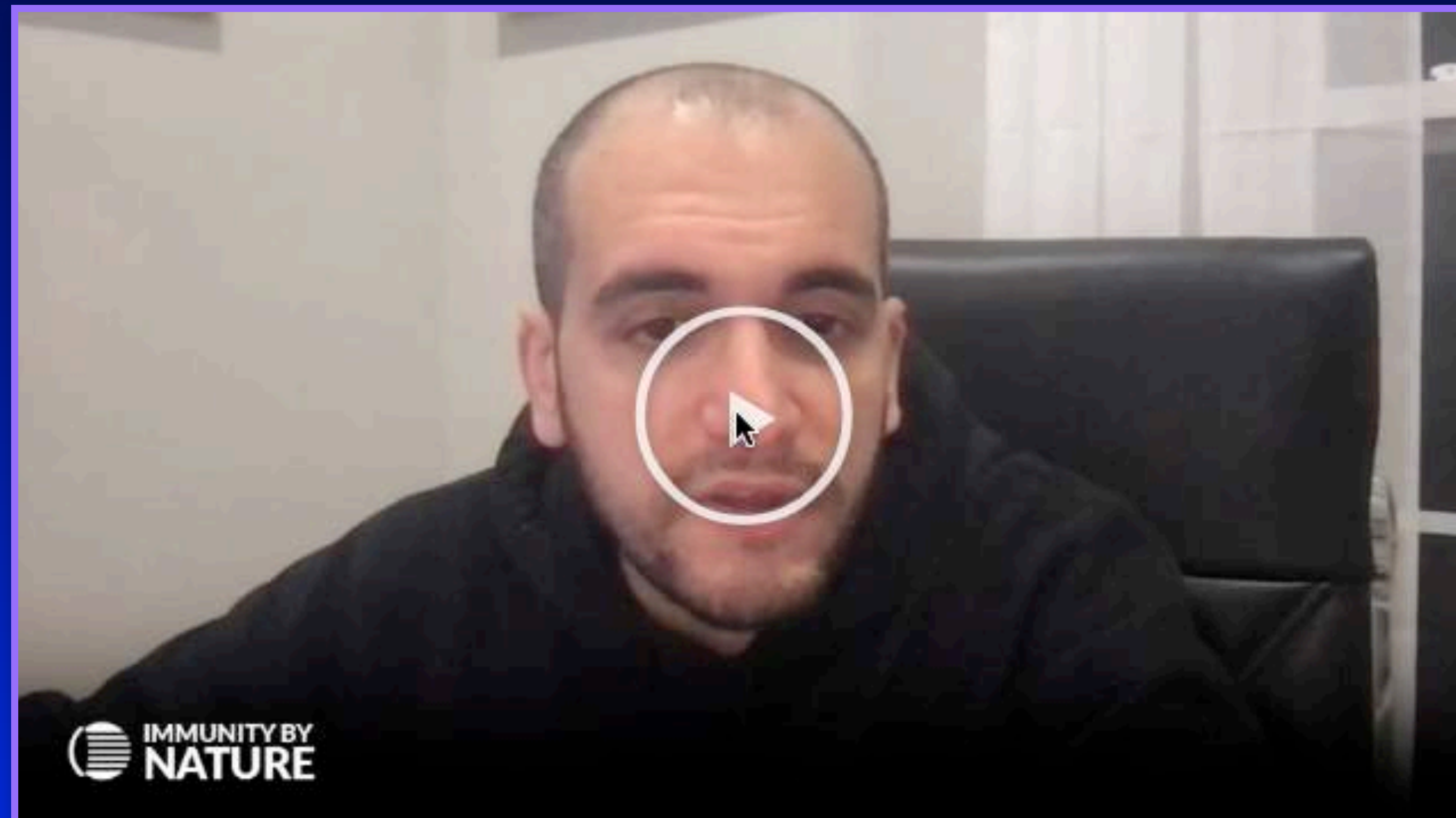

FrequencyShop.co

FrequencyShop.co

Hi Dr. Gerald, Welcome Back!

Home About How It Works Testimonials FAQ Affiliate Program Contact

Go To My Account

Need to resolve acute or chronic pain?

Need your immune system **BOOSTED?**

Need energy healing for other health problems?

Silver Plan

18 Healing Frequencies Including:

- ✓ Scalar Energy
- ✓ Vanish
- ✓ Pain Away I (Topical)
- ✓ Pain Away II (Internal)
- ✓ Detoxification
- ✓ Ozone
- ✓ Anti-Aging
- ✓ Allergy Remedy
- ✓ Silica 30C
- ✓ QuantumMectin
- ✓ QuantumChloroquine
- ✓ Infrared
- ✓ Bleeding Gums
- ✓ Improving Short Term Memory
- ✓ Healing the Stomach/Intestines
- ✓ Improving Long Term Memory
- ✓ Clearing Program
- ✓ Magnesium Orotate
- ✓ **BONUS:** Immune Boosting & Energy Maximizing Frequency

\$19.95
Per Month

7-DAY FREE TRIAL

Gold Plan

Everything in Silver Plan PLUS:

- ✓ Stress Relief
- ✓ Vitamin C (food based)
- ✓ Mental Clarity
- ✓ New Sleep Aid
- ✓ Arthritis Program
- ✓ General Tiredness
- ✓ Acne
- ✓ Chronic Fatigue
- ✓ Severe Chronic Fatigue
- ✓ Detox Glyphosate
- ✓ Congestive Heart Failure
- ✓ Detox Chem Trails
- ✓ Shingles
- ✓ Parasites
- ✓ Serotonin
- ✓ Core Maca Gold
- ✓ Quantum Thyroid
- ✓ Full Spectrum Vitamin K
- ✓ Resveratrol
- ✓ Nattokinase
- ✓ Humic/Fulvic Acids + 74 Trace Minerals
- ✓ Melatonin
- ✓ L-Arginine
- ✓ Glutathione
- ✓ Evening Primrose Oil
- ✓ CoQ10
- ✓ Cat's Claw
- ✓ Vitamin A (beef lipids)
- ✓ Herpes 2 Plus

\$49.95
Per Month

JOIN NOW

Platinum Plan

Everything in Silver & Gold Plans PLUS:

- ✓ Immune Booster for Cancer
- ✓ Sleep Like a Baby
- ✓ Curcumin
- ✓ Hypothyroidism Program
- ✓ Hypoadrenia Program
- ✓ Universal Frequency for Manifestations
- ✓ Heal DNA Program
- ✓ Heavy Metal Detox
- ✓ Adaptogen Program
- ✓ Regenerate the Liver Program
- ✓ CoQ10 supplement Program
- ✓ HGH Male (Human Growth Hormone)
- ✓ HGH Female (Human Growth Hormone)
- ✓ Herbal C (Detox for Cancer)
- ✓ Testosterone Replacement Program
- ✓ Progesterone Replacement Program
- ✓ Migraine Headache Program
- ✓ COVID Tx Program
- ✓ Quantum WT
- ✓ **BONUS:** BioPhoton Program
- ✓ **BONUS:** Calming Program

\$79.95
Per Month

JOIN NOW

Natural Vitamins
vs
Synthetic

BIOPHOTONS

Basis of Life

Research by Fritz Albert Popp, Ph.D documented the presence of biophotons in human cells and living plants. Consuming raw foods, food based supplements and homeopathic remedies helps restore the cell's energy. Raising the level of energy within cells restores normal physiology and health.

BIOPHOTONS

Biophoton emission is a general phenomenon of living systems. It concerns low luminescence from a few up to some hundred photons per second per square centimeter surface area. At least within the spectral region from 200 to 800nm. The experimental results indicate that biophotons originate from a coherent photon field within the living organism, its function being intra and inter cellular regulation and communication.

Published in:

"Macroscopic Quantum Coherence",

Proceedings of an International Conference on the

Boston University, edited by Boston University and MIT, World Scientific 1999.

SYNERGISTIC FACTORS

Food Based Supplements

Food and food based supplements provide the matrix for carrying biophotons, frequencies, and synergistic factors (electromagnetic or unknown forms) that we do not even know exist.

SYNTHETIC VITAMINS

Hampers Healing

Research by Fritz Albert Popp, Ph.D documented that synthetic vitamins lack biophotons. Synthetic vitamins are chemical agents that work pharmacologically. Examples: High doses of vitamin C works like an anti-histamine.

*Synthetic
supplement*

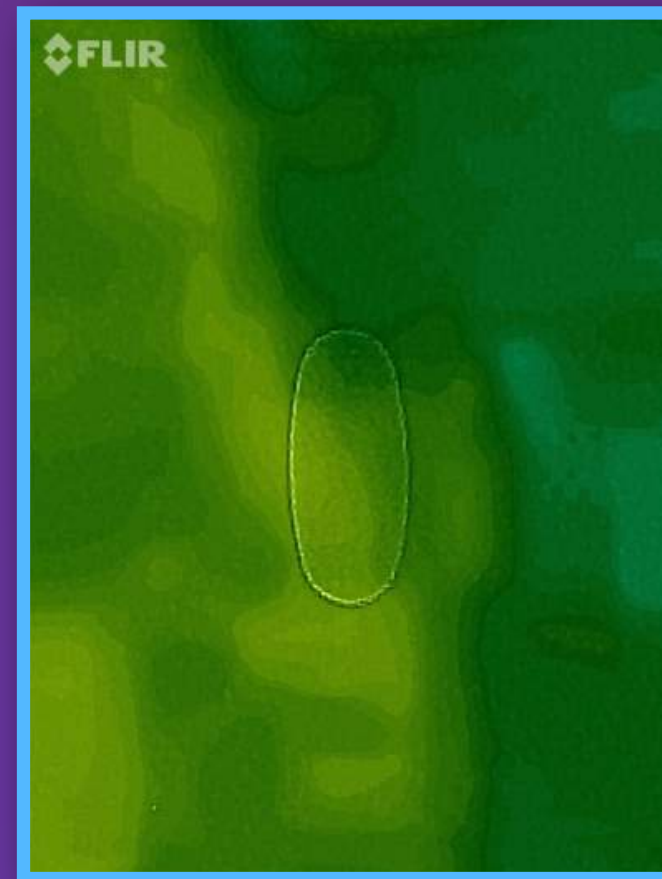

*Food based
supplement*

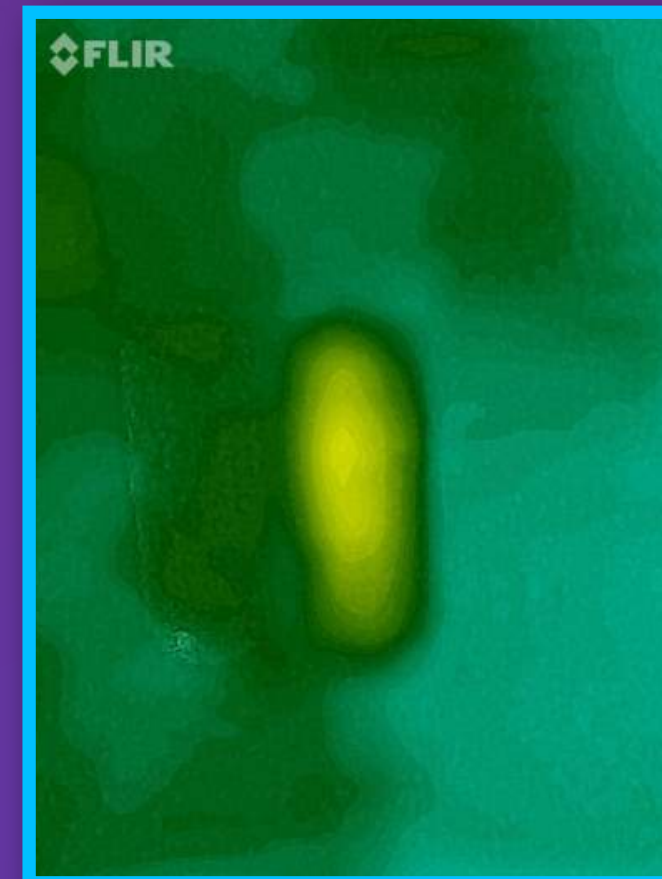

SYNTHETIC VITAMINS

Hampers Healing

Synthetic and /or crystalline-pure fractions of vitamin complexes can impair biochemical balance, destroy health and reduce life span.

Royal Lee, DDS Founder of Standard Process Labs